

Constant Performance Degassing Pump Product Suite

PROPRIETARY - This document and all information herein is the proprietary property of IDEX Health & Science LLC. Any copying, reproduction or unauthorized use without written consent is forbidden.

Table of Contents

CONSTANT PERFORMANCE DEGASSING PUMP PRODUCT SUITE	3
DESCRIPTION.....	3
RELATED PARTS	3
VACUUM PUMP WITH CONSTANT PERFORMANCE PCB	4
DESCRIPTION.....	4
CONSTANT PERFORMANCE VACUUM PUMP SPECIFICATIONS.....	4
DIMENSIONAL DRAWINGS	7
VACUUM PUMP RUN CHARACTERISTICS	9
SEPARATE SALE DUAL STAGE PUMP	10
DESCRIPTION.....	10
PUMP SPECIFICATIONS (TYPICAL).....	10
DIMENSIONAL DRAWINGS	11
SEPARATE SALE PCB.....	12
DESCRIPTION.....	12
DIMENSIONAL DRAWINGS	12
OPTIONAL MANIFOLD DEVELOPMENT KIT	13
DESCRIPTION.....	13
DIMENSIONAL DRAWINGS	13
REGULATORY COMPLIANCE INFORMATION	14
REFERENCING DOCUMENTS	14

Constant Performance Degassing Pump Product Suite

Description

This specification document highlights all the part numbers and components associated with the constant performance degassing pump (CPDP) system. This intelligent, user defined control system, when used with our film degasser 9000-2071, will provide more performance, increased efficiency and tighter control for HPLC instrument precision & reliability.

A new method of in-line HPLC degassing control is being introduced by characterizing the efficiency of a new, high performance flat film degasser at various applied vacuum levels. The resulting calibration data produces a mathematical model of degassing channel performance that allows the HPLC system to operate the vacuum degasser at the highest possible pressure (minimal vacuum level) to degas the mobile phase without affecting the performance of the HPLC system. This, in turn, minimizes pervaporation and concentration changes in the mobile phase, as well as reducing solvent vapor exhausted to the atmosphere. Because vacuum is adjusted using pump RPM, higher pressure operation reduces pump wear. Degassing above the vapor pressure(s) of the mobile phase also reduces concern for concentration changes across the full flow rate range of the HPLC system.

Related Parts

Part Number	Part Description	Comments
9000-2090	Assy, VacPump, BtmMnt, w/CP PCB	Bottom Mount Pump with PCB
9000-2091	Assy, VacPump, SideMnt, w/CP PCB	Side Mount Pump with PCB
9000-2088	Assy, VacPump, BtmMnt, CPDP	Bottom Mount Pump ONLY
9000-2089	Assy, VacPump, SideMnt, CPDP	Side Mount Pump ONLY
9000-2092	PCB CP, 120mmHg	CPDP PCB
9000-2094	Kit, Manifold w/hardware, CPDP	CPDP Manifold Hardware
9000-2095	Kit, Manifold, CPDP	Manifold Spares
9000-2096	10-Pack Connectors, CPDP	Connectors Spares
9000-2097	10-Pack Plugs, CPDP	Plugs Spares
9000-2098	10-Pack Elbows, CPDP	Elbow Spares

Vacuum Pump with Constant Performance PCB

IDEX PN: 9000-2090 (Bottom Mount) & 9000-2091 (Side Mount)

Description

The Dual-Stage Pump (DST) with Constant Performance PCB is a vacuum control system for use with IDEX Film Degasser chambers. The system includes a DST vacuum pump and a controller PCB that operates in two modes.

1. Consistent with legacy degasser pumps, the control system will maintain vacuum levels at a user-defined setpoint (default 120mmHg).
2. Optionally, the Constant Performance algorithm allows the user to set a flow rate and desired efficiency, from which the control algorithms will determine the nominal vacuum level.

Constant Performance Vacuum Pump Specifications

Power Requirements

15-24 VDC @ 0.75 Amp max. (< 5 Watts consumption average)

Temperature

- Storage: -29°C to 60°C
- RH: 15% to 85% noncondensing
- Operating: 1°C to 60°C

Vacuum Flow Path Material

316L Stainless Steel, Polypropylene, PTFE, EPDM Rubber

Vacuum Accuracy

±10mmHg from setpoint

Closed-Loop Control Setpoint

Default 120mmHg

LED Indicators or Optional Error Outputs

This section describes how the pump operation behaves during startup and into normal operation. Error conditions are detected during startup and later during normal operation. Ambient pressure is measured at startup and used when calculating vacuum efficiency. The system stores the ambient pressure reading in non-volatile memory. Ambient pressure is updated when a significant difference is detected from previously stored value.

The charts below depict the behavior of the vacuum system and the LED indicators. The examples assume a setpoint of 120 mmHg.

In a normal pumpdown the LED flashes amber until it reaches setpoint + 30 mm. Then it flashes green until reaching the setpoint. At the setpoint it will turn solid green. If it dips below the setpoint it will flash green (not depicted).

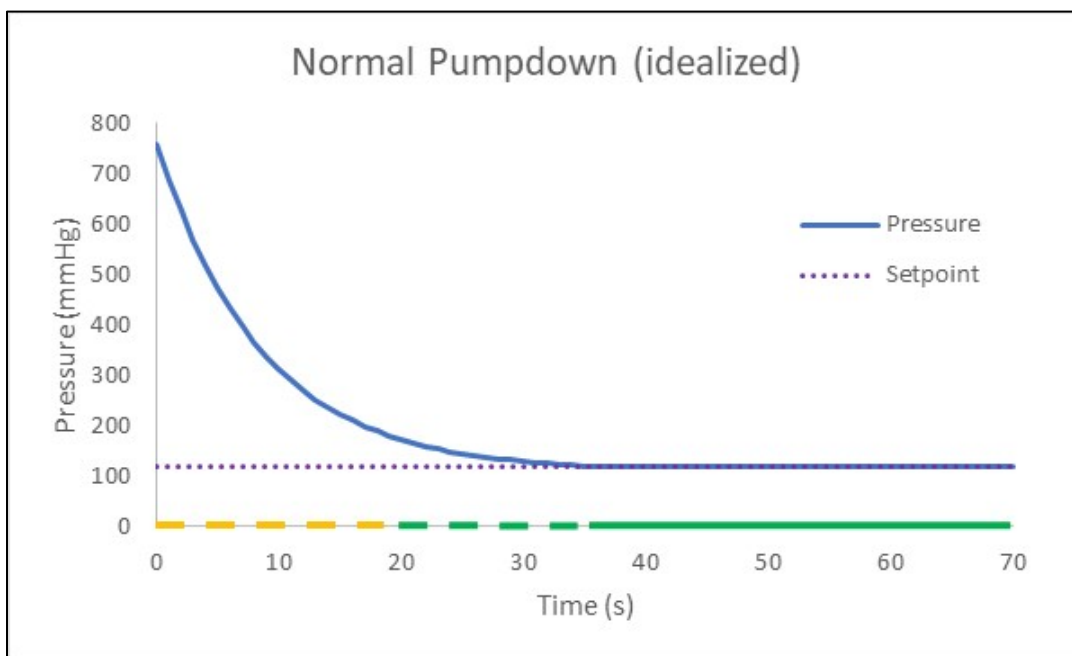

If the pressure is unable to reach the setpoint after 10 minutes, the pump will stop and the LED will turn solid RED.

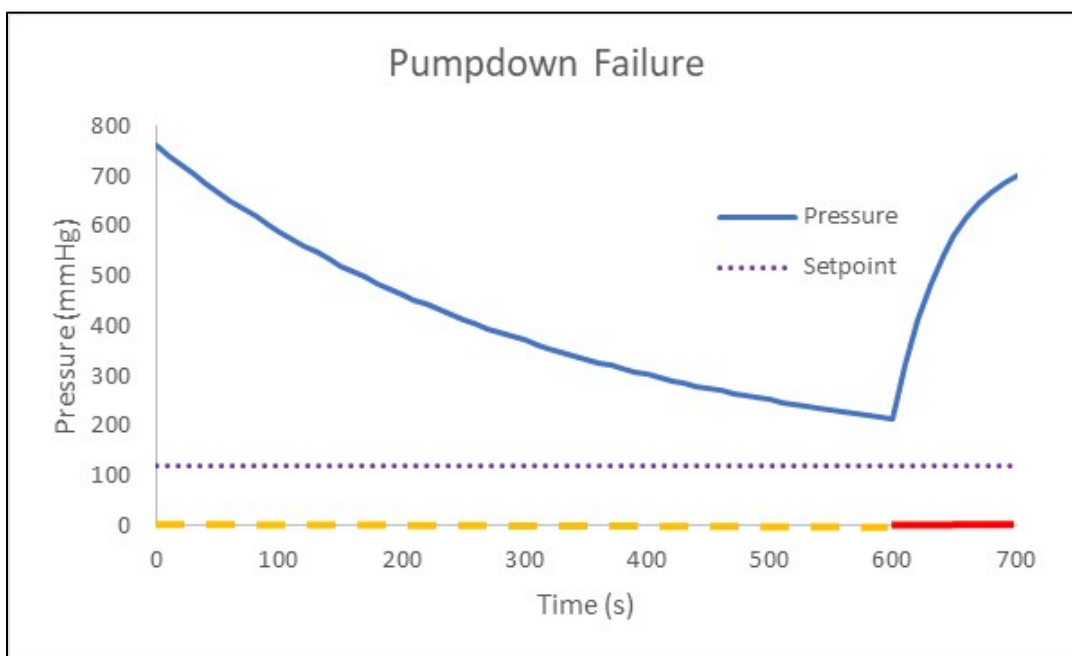

If the pressure reached the setpoint then later there was a vacuum loss, the LED will flash amber while it is 30 mm or more above the setpoint, flash green when less than 30 mm above the setpoint, then solid green when it reaches the setpoint. If during a temporary vacuum loss it is unable to reach the setpoint for 6 minutes, the pump will stop and the LED will turn solid RED (not depicted).

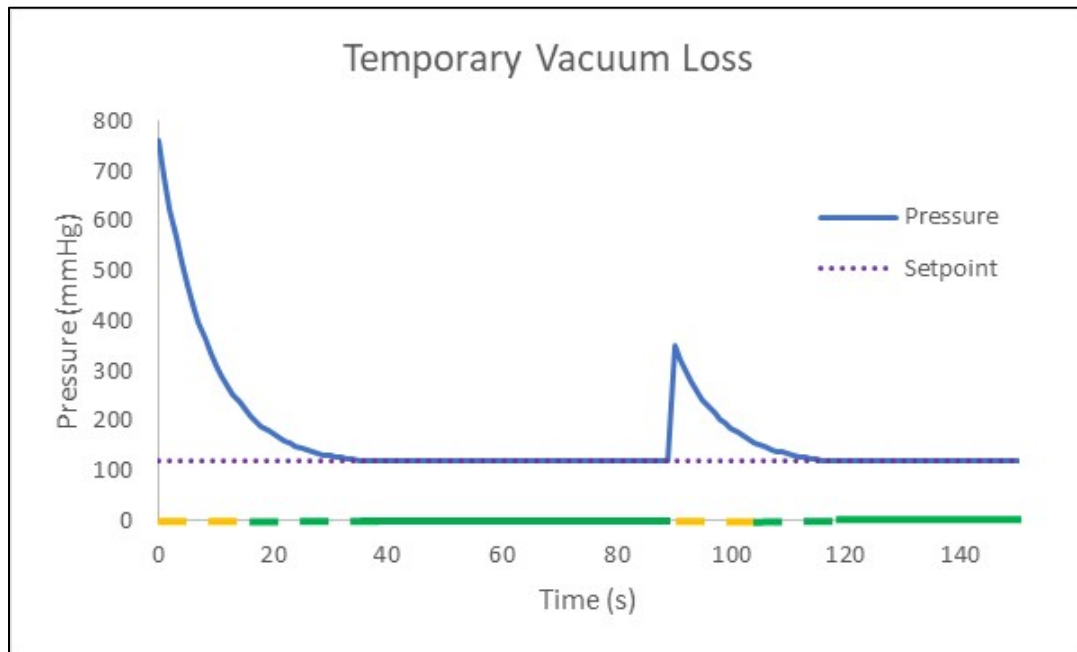

If at any time the pressure is more than 30 mm above the setpoint and the vacuum is not dropping at all, the pump will stop in a few seconds and the LED will turn solid RED. This indicates a catastrophic loss of vacuum with no ability to pump it down. This may be caused by an open vacuum line. If this occurs at startup, the pump will run for a few seconds and then stop.

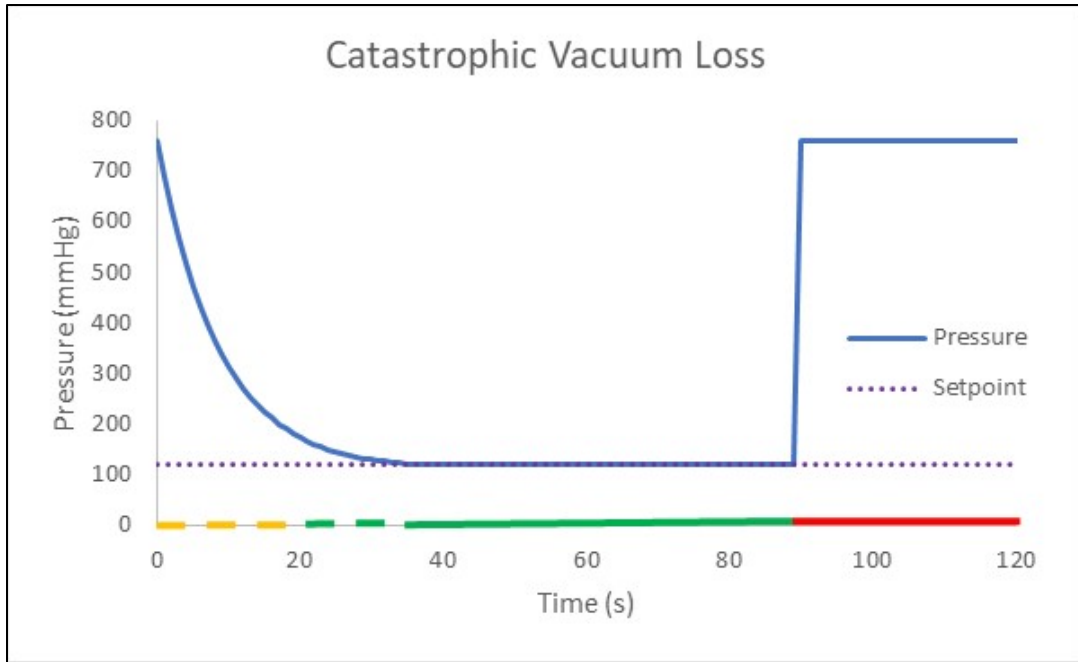

Dimensional Drawings

Dimensions are in [millimeters] and inches. For Reference ONLY

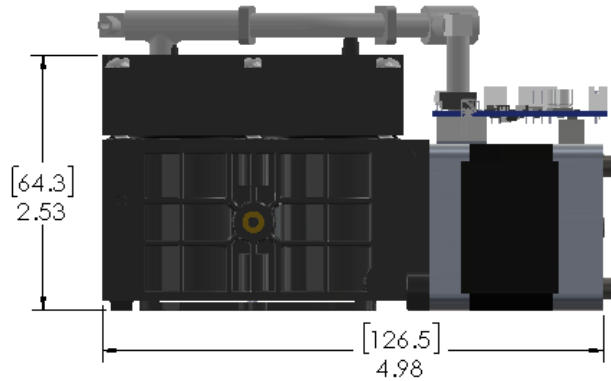
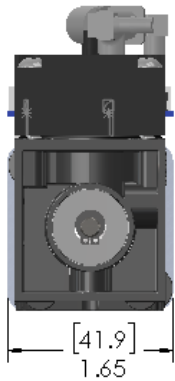
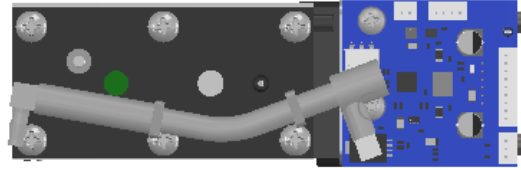
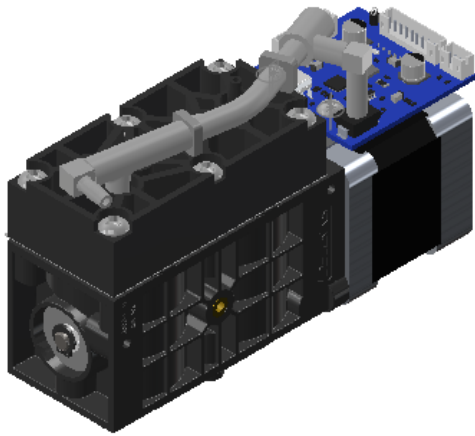

Part Number	Description
9000-2090	Assy, VacPump, BtmMnt, w/CP PCB
9000-2091	Assy, VacPump, SideMnt, w/CP PCB

Vacuum Pump Run Characteristics

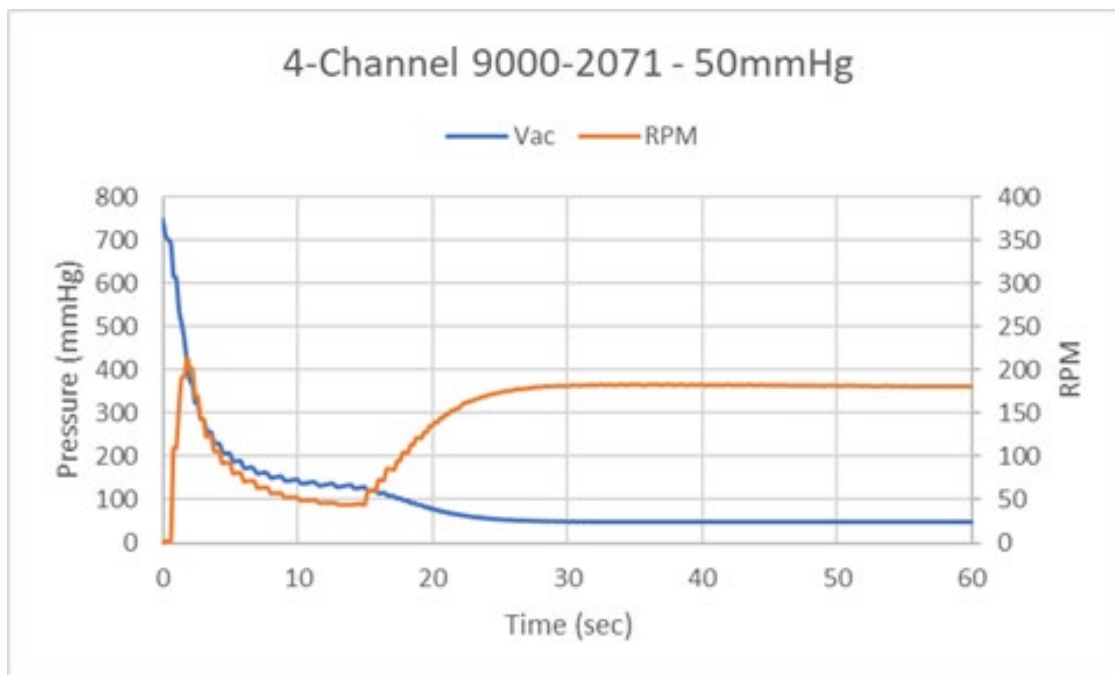
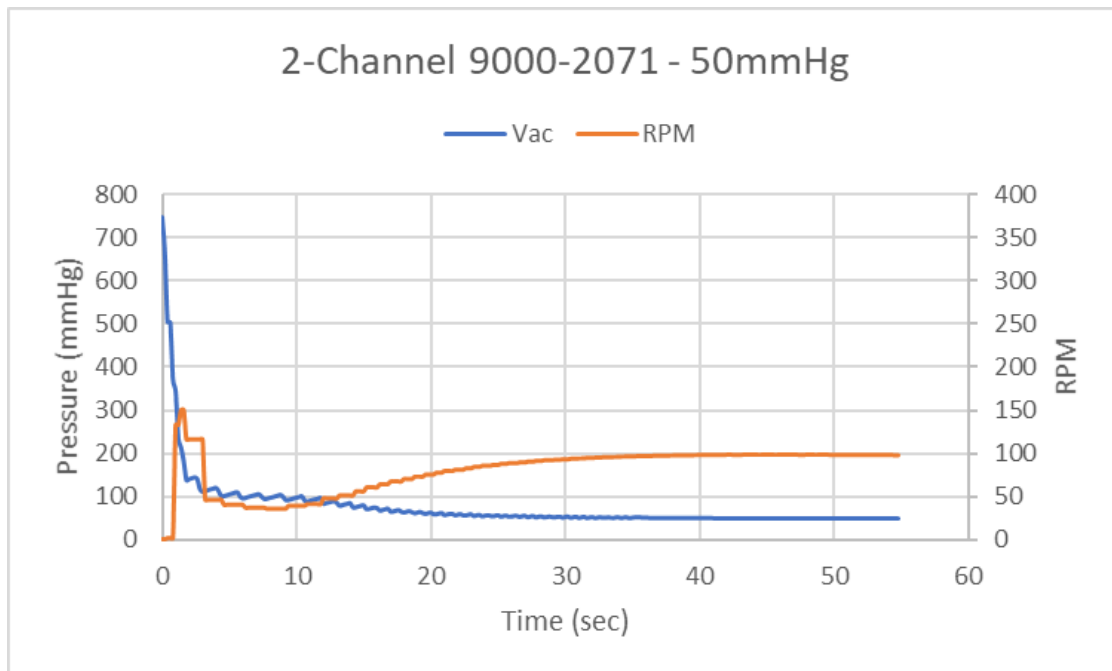

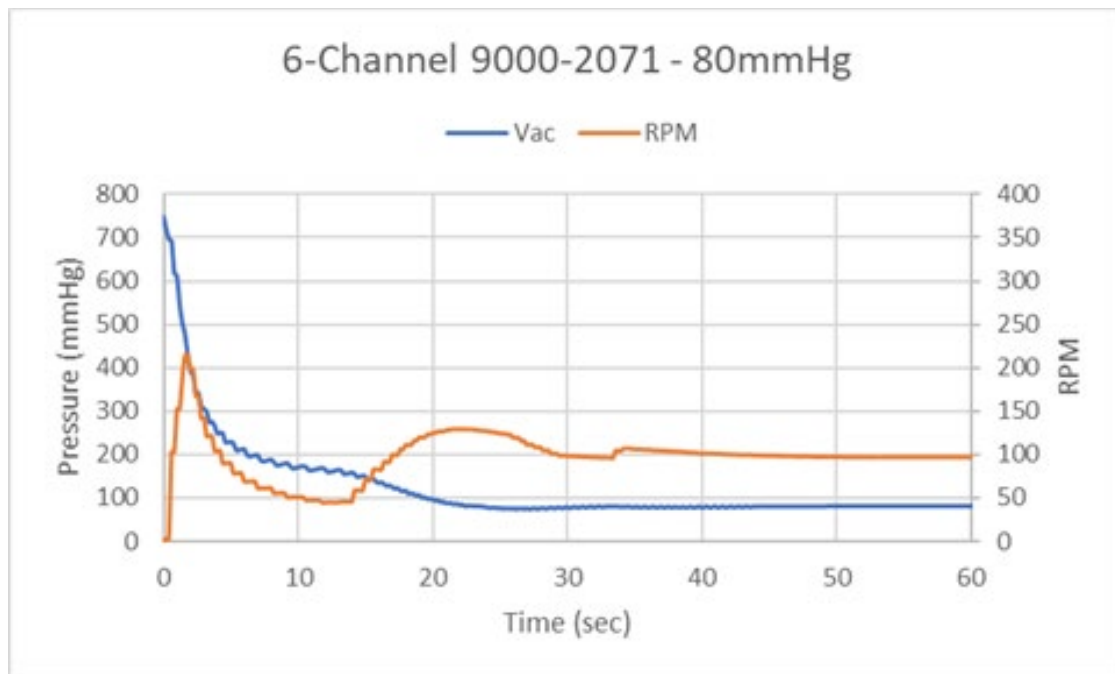

Separate Sale Dual Stage Pump

IDEX PN: 9000-2088 (Bottom Mount) & 9000-2089 (Side Mount)

Description

These Dual Stage Pump (DSP) are for use with IDEX Film degassing chambers and Constant Performance PCB control systems. The pump is available with side and bottom mount versions.

Pump Specifications (Typical)

- Air Flow (no vacuum): 650 SCCM @ 400 RPM; 100 SCCM @ 60 RPM
- Pump-down Time: < 1 minute [up to ten (10) 9000-2071 degassing chambers]
- Wetted Materials: 316L Stainless Steel, Polypropylene, PTFE, EPDM Rubber
- Stepper motor step angle: 1.8°
- Motor winding resistance: 4.4 ohm
- Motor max rated current: 1 Amp
- Typical Preset Vacuum Performance: 120 mmHg @ (120±10) RPM (4 Channels of 9000-2071 open to atmosphere)
- Pump Head Continuous Purge Air Flow Rate: ~30 SCCM
- Noise levels: Less than 60dB up to 400RPM A-weighted
 - Collected in an open environment at 1 meter from the pump running at various RPM settings with an IEC 61672-2013 Class 2 compliant device calibrated to the IEC 60942-1997-11 standard.
 - Ambient noise levels measured at 35.5dB.
 - Different mounting and custom system configurations will alter natural frequency and noise output

Dimensional Drawings

Dimensions are in [millimeters] and inches. For Reference ONLY

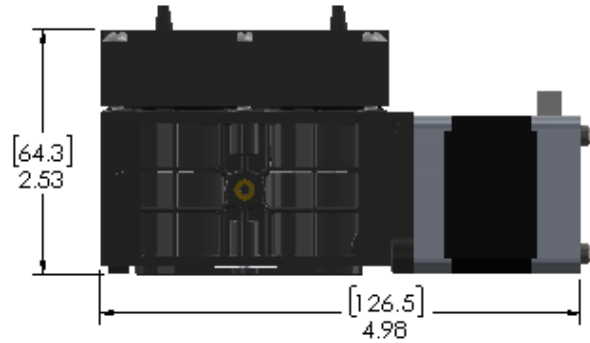
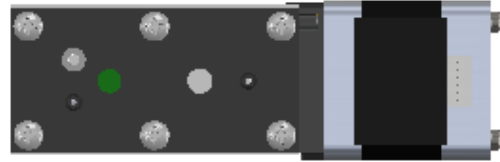
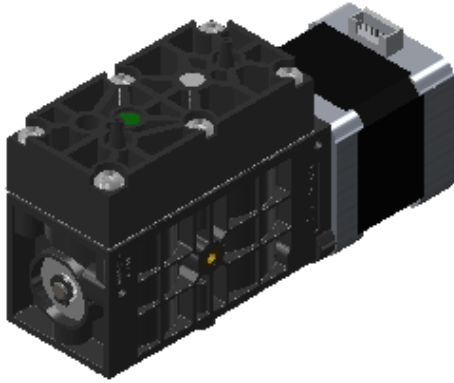

Part Number	Description
9000-2088	Assy, VacPump, BtmMnt, CPDP
9000-2089	Assy, VacPump, SideMnt, CPDP

Separate Sale PCB

IDEX PN: 9000-2092

Description

This separate sale PCB includes mounting hardware (adhesive, screws, PCB) and enables Constant Performance Control methodology. The PCB comes at a 120mmHG default setpoint.

Dimensional Drawings

Dimensions are in [millimeters] and inches. For Reference ONLY

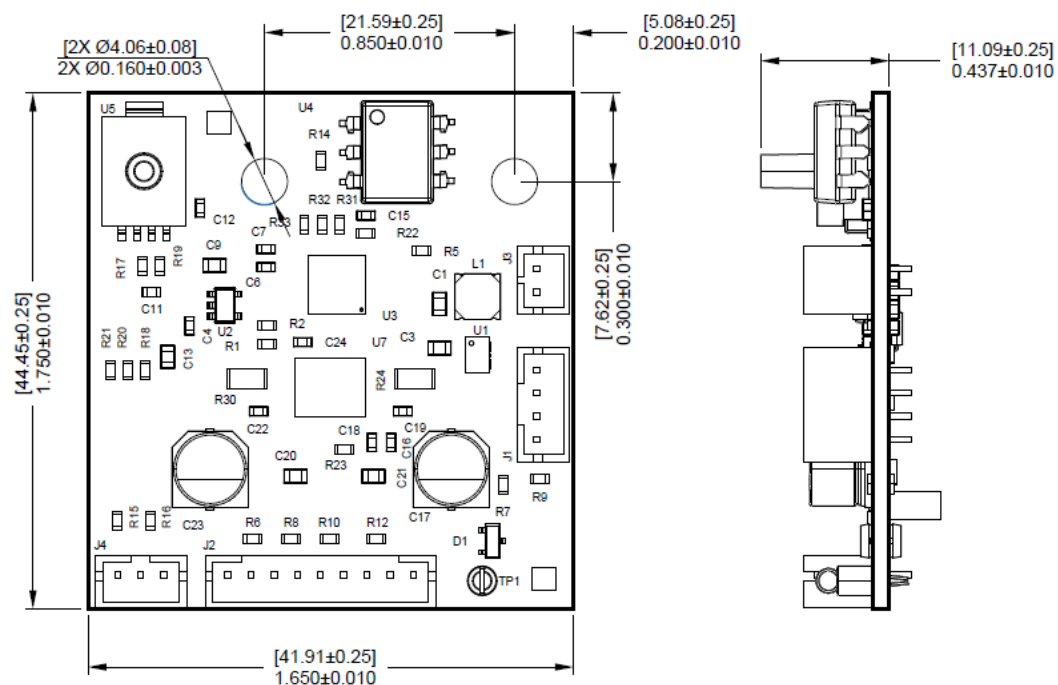
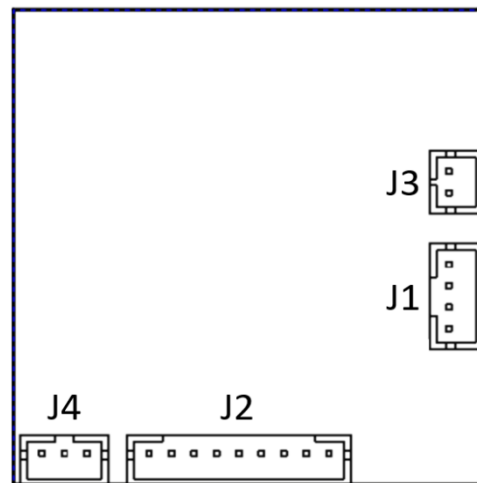
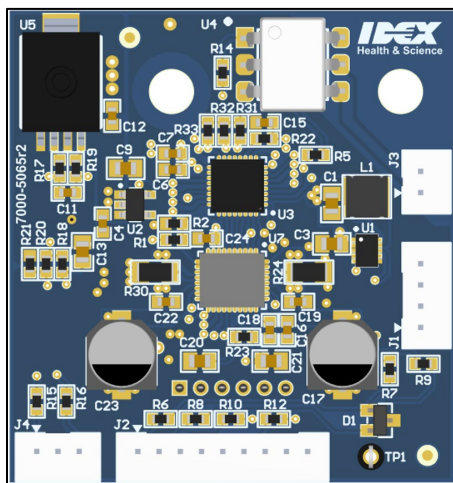

Optional Manifold Development Kit

Description

IDEX Health & Science has compiled components as a manifold kit to facilitate rapid evaluation of the constant performance methodology. Kit components can be paired flexibly with the 9000-2090 and 9000-2091 Pump/PCB combinations supporting up to six Film Degasser chambers.

Part Number	Description	Material
9000-2094	Kit, Manifold w/hardware, CPDP	Santoprene
9000-2095	Kit, Manifold, CPDP	Santoprene
9000-2096	10-Pack Connectors, CPDP	Nylon
9000-2097	10-Pack Plugs, CPDP	Nylon
9000-2098	10-Pack Elbows, CPDP	Nylon

Dimensional Drawings

Dimensions are in [millimeters] and inches. For Reference ONLY

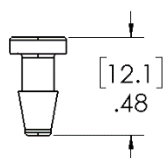
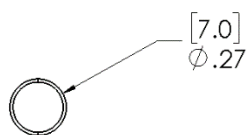

Plug

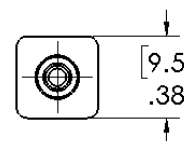
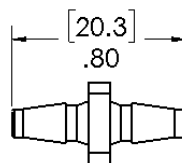

Connector

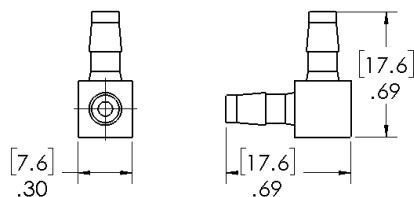

Elbow

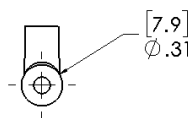

Manifold

Regulatory Compliance Information

This product is compliant with current RoHS3 & REACH regulations

Referencing Documents

Constant Performance PCB Pump Driver: Communications & Commands

This separate document details the PCB connectors, communication, and command protocols, along with sample code to facilitate usage.

Film Degasser Chamber Product Datasheet

This is a separate document detailing product specification, dimensional drawing, degassing efficiency & fluidic resistance details and chemical compatibility of the 500 μ L degassing chamber in a flat film format.

Constant Performance HPLC Degassing White Paper

This separate document details the science behind our new method of in-line HPLC vacuum degassing control which is introduced by characterizing the efficiency of a new, high performance flat film degasser at various applied vacuum levels.

Please ask your IDEX Health & Science representative for a copy.