

# Standard Port Drawing

1/4-28 Coned, for 1/8 OD tubing

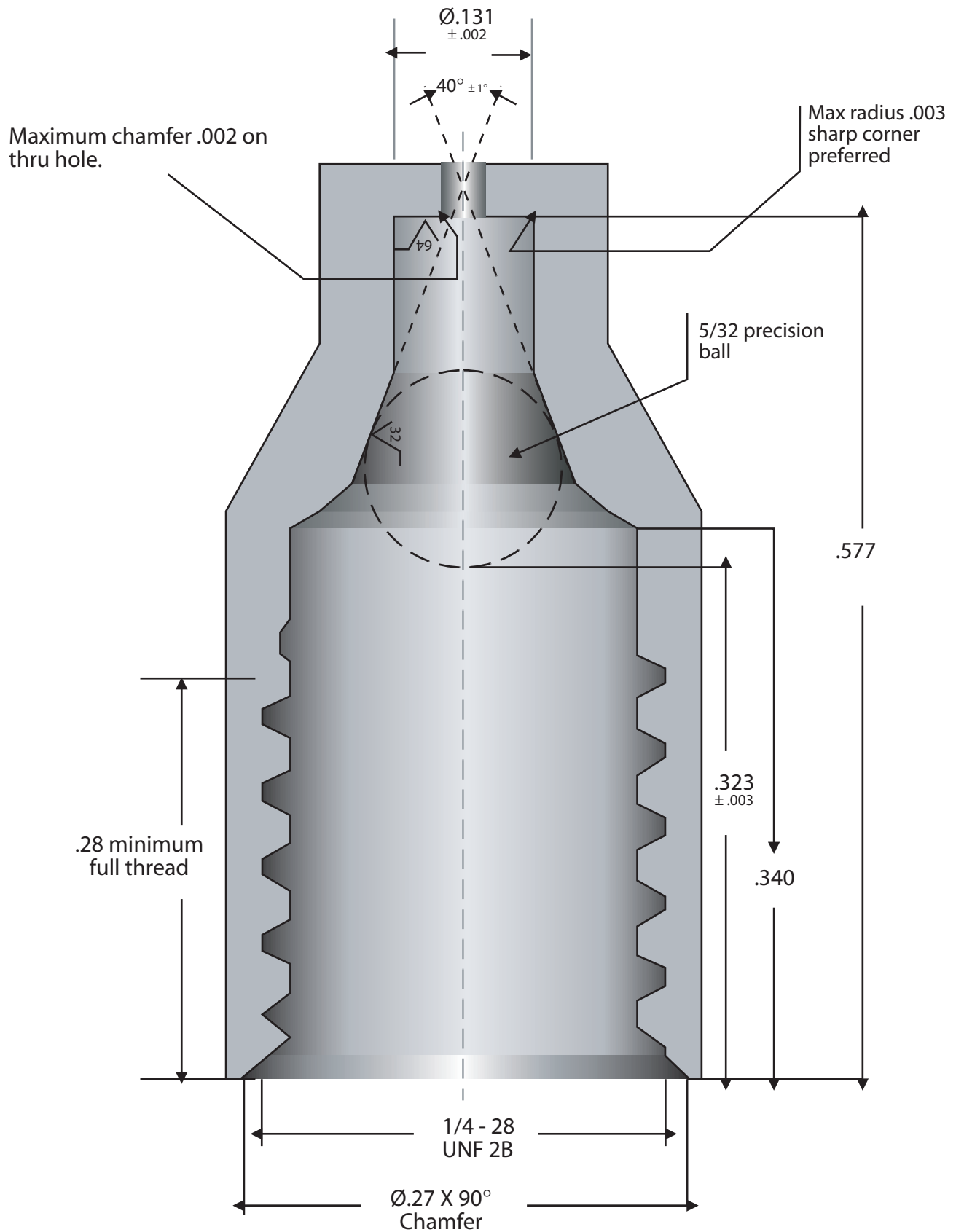

The dimensions shown on this drawing are subject to change without notice.